

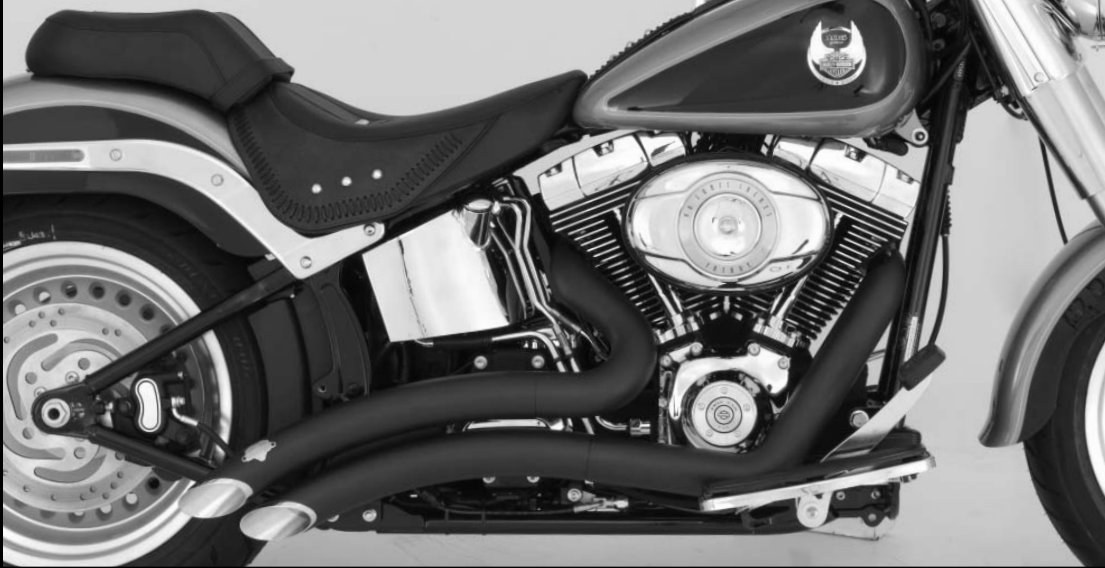







**MORE POWER : LESS NOISE**



Congratulations, you have purchased the finest exhaust system for your motorcycle on the market. Your Vance & Hines exhaust system is designed and crafted for maximum performance, a perfect fit, a great sound and unbeatable style. Please follow the installation instructions below and if you have any questions, please call our technical support line at (562) 926-5291.

Attention installer (if other than owner), please forward this instruction sheet to the owner of this product. These instructions contain valuable information to the end user.

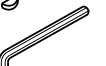
**TOOLS  
REQUIRED**

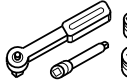
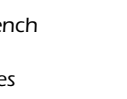
-  Flat blade screwdriver
-  5/16" Nutdriver
-  1/2", 9/16" & 7/8" or 22mm Combination wrenches
-  3/16" & 5/16" Allen wrench
-  T45 & T50 Torx wrenches
-  Snapping pliers
-  3/8" Ratchet, extensions
-  1/2" & 9/16" Sockets

**READ ALL INSTRUCTIONS BEFORE BEGINNING INSTALLATION**

**STOCK EXHAUST  
SYSTEM REMOVAL**

**NOTE:** These instructions are written for late model motorcycles equipped with O2 sensors. If you are installing these pipes on a bike which is not equipped with O2 sensors, ignore all instructions which reference them. Additionally you will need to purchase an O2 sensor block off kit P/N 16925. However this kit does contain all necessary hardware to install the right side passenger footpeg on '86-'06 model softtails (see packing list).

- Under the oil tank on the right hand side, locate the rear O2 sensor connector. Unplug sensor and feed the end of wire through the frame freeing it from motorcycle. NOTE: Pay attention to wire routing for re-installation.
- Open the plastic cover above the rectifier on front of the frame to gain access to the front O2 sensor connector. Unplug sensor from harness. Remove cable tie holding wire to frame and feed the end of the wire through freeing it from motorcycle.
- On FLSTC, FLSTF, FLSTN and FLSTSC models, loosen the right hand floor board mounting bolts to gain clearance for exhaust removal and installation.
- Loosen the heat shield clamps on both front and rear exhaust pipes.

- Remove the two mounting nuts from each head pipe, located at the cylinder head.
- If equipped, unbolt the carriage bolt and clamp attached to the bracket under the right side transmission cover.
- Remove the nuts attaching the exhaust mount bracket to the frame.
- On FLSTD and FLSTF models, you will need to remove the right side passenger footpeg and hanger, as this is attached to the exhaust mount bracket. Replace the passenger foot peg assembly using the 3/8" x 2 1/2" Allen bolt (supplied).
- Remove the entire exhaust system and set it aside.
- If equipped, remove the bracket from under the right side transmission cover.
- Using a 7/8" or 22mm wrench, carefully remove the O2 sensors from the stock head pipes and save for re-use with the new system.
- Remove the two lower mounting studs from the frame (Figure 1).
- Carefully remove exhaust port flanges and circlips from the stock exhaust system using snapping pliers. NOTE: Replace bent or damaged circlips. Check exhaust port gasket condition. Recommended replacement exhaust port gaskets, Harley part number: 17048-98 or 65324-83A.

**FIGURE 1**

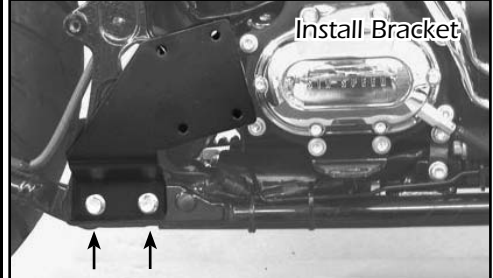

**FIGURE 2**



**FIGURE 3**

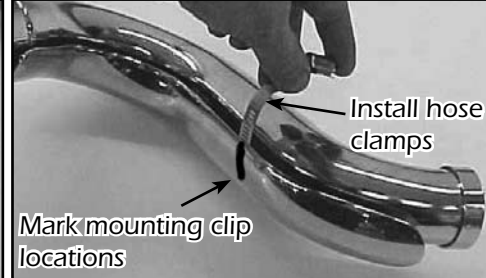

**FIGURE 4**

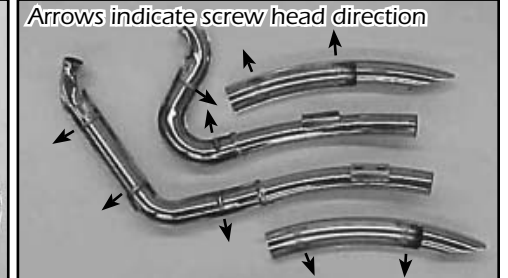

**FIGURE 5**

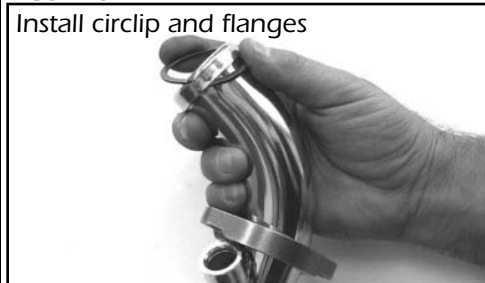

**FIGURE 6**



**FIGURE 7**

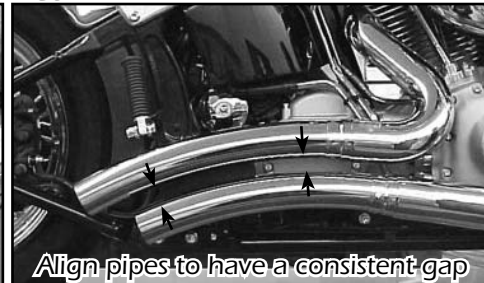

**FIGURE 8**

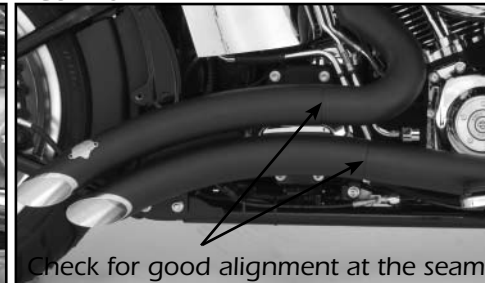

**VANCE & HINES EXHAUST SYSTEM INSTALLATION**

1. Install bracket (stamped 352-P)(supplied) using the two lower holes in the frame below the right passenger footpeg, using two 3/8"x3/4" flange bolts (supplied)(Figure 1).
2. Remove head pipes and heat shields from protective packaging. Place each heat shield on a non-abrasive surface such as a blanket or carpet. Using a pencil, lightly mark outside edge of each heat shield to show location of mounting clips that hose clamps will loop through (Figure 3). NOTE: Pencil marks can be erased if care is taken not to harm coating.
3. Lay head pipes into head pipe heat shields (Figure 2) and loosely install the #20 hose clamps (supplied) into mounting clips (Figure 3). NOTE: Muffler heat shields will be installed after pipes are on the motorcycle. Screw heads should be accessible when system is installed on motorcycle for adjustment purposes (Figure 4). Do not tighten at this time.
4. Apply a small amount of anti-seize compound to the threads of the O2 sensors and install them into the new head pipes. NOTE: Be careful not to get anti-seize on sensor tip, it may affect sensor function.
5. Install circlips and flanges from stock system onto both new head pipes (Figure 5).
6. Using stock flange nuts, carefully install head pipes onto motorcycle. Do not tighten at this time.
7. Use the nut plates and 5/16"x5/8" flange bolts (supplied) to attach the pipes to the bracket (Figure 6). Do not tighten at this time.
8. Align pipes on motorcycle so the gap between the two muffler bodies is consistent from front to rear (Figure 7). Tighten the exhaust port flange nuts, the 5/16"x5/8" flange bolts (supplied) and the 3/8"x3/4" flange bolts (supplied) attaching the bracket to the frame.
9. Using the #28 hose clamps (supplied) install the muffler heat shields. Beginning with the D322HP on the front head pipe followed by the D323HP on the rear head pipe. Screw heads should be accessible for adjustment purposes (Figure 4). Do not tighten at this time.
10. Adjust all heat shields for the best alignment at the seam where they meet (Figure 8) and tighten all the hose clamps.
11. Feed wire for the front O2 sensor through the frame and into the plastic holder on the frame. Plug the sensor into the stock wiring connector. Snap the plastic holder closed to hold the connector in place.
12. Install a new nylon cable tie (supplied) to hold the wires onto frame in the original location.
13. Feed connector for the rear O2 sensor through the frame under the oil tank on the right hand side. Plug the sensor into the stock wiring connector.
14. Re-tighten floor board mounting bolts on models so equipped.
15. After installation and before starting your motorcycle, completely clean pipes and heat shields with warm soapy water and a clean soft cloth. Dry with a clean towel. NOTE: any residue, oil, or fingerprints will stain the black coating. Do NOT use anything abrasive to clean the pipes as it may remove the finish.
16. Be sure to tighten all hardware before starting motorcycle. We also recommend checking that the Chrome endcap screws are tight from time to time.

**EXHAUST CARE - HELPFUL HINTS TO AVOID DISCOLORATION OF EXHAUST SYSTEM**

1. When installing a new set of black pipes, make sure your hands are clean and free of oil. After installation, thoroughly clean pipes with warm soapy water and a soft cloth. Dry with clean towel to remove any residue before starting the motorcycle. Do NOT use anything abrasive to clean pipes.
2. Avoid long periods of idling as this can cause discoloration.
3. Intake leaks can cause the engine to run lean and overheat, this could lead to discoloration.
4. Make sure there are no exhaust leaks at the junction of the exhaust pipes and cylinder head. We recommend replacing gaskets if they are worn.

**VANCE & HINES OPTIONAL ACCESSORIES**

**FUELPAK**



**FUEL MANAGEMENT:**

Take the guess work out of fuel injection with Fuelpak Fuel Management, P/N 61001. Contact your local dealer or call (562) 921-0071 to order. Visit fuelpakfi.com for more information.

Fuelpak is intended for racing or off-highway use only, and is not legal for sale or use in California on pollution-controlled vehicles.

PLEASE NOTE: Every effort is made for Vance & Hines Exhaust Systems to provide improved cornering clearance. However, due to design and space limitations on some motorcycle models, ground and cornering clearance may not be improved and in some cases may be reduced. Be sure to follow proper installation instructions.



**PACKING LIST**

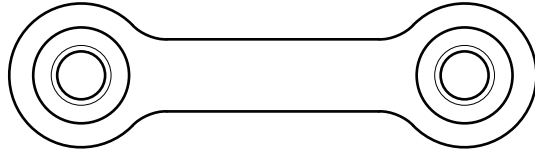

Nut plate x 2

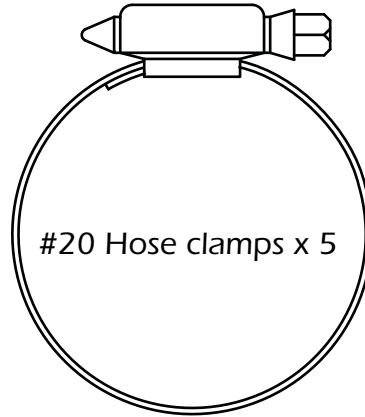

#20 Hose clamps x 5



1/2" x 3" Allen bolt x 1 (for '86-'99 models only)

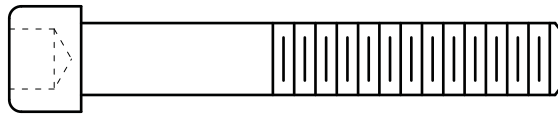

3/8" x 2-1/2" Allen bolt x 1



1/2" Spacer x 1 (for '86-'99 models only)

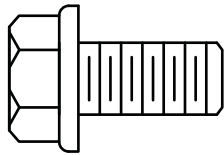

3/8" x 3/4" Flange bolts x 2

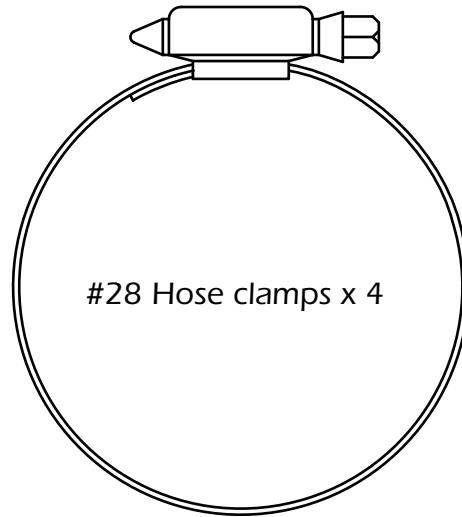

#28 Hose clamps x 4

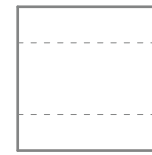

3/8" Spacer x 1 (for '00-'06 models only)

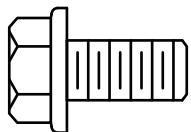

5/16" x 5/8" Flange bolts x 4



Nylon cable tie x 1

**PARTS NOT SHOWN:**

- 352-P Bracket x1
- D457FP Front head pipe x1
- D458FP Rear head pipe x1
- D457HP Front heat shield x1
- D458HP Rear heat shield x1
- D322HP Front muffler heat shield x1
- D323HP Rear muffler heat shield x1
- D324EC Chrome tips x2 (installed)

**WARRANTY**

Vance & Hines exhaust systems are warranted against defects in material and workmanship for a period of 90 days from the date of purchase from an authorized dealer. This warranty does not cover discoloration of chrome finishes. This warranty is limited to the repair or replacement of a product proven to be defective from normal use. Vance & Hines exhaust systems are designed to fit and operate on OEM motor and chassis. This warranty does not cover any product subject to abuse, misuse, improper installation or modification.

**MORE POWER : LESS NOISE**

**ALL PARTS SHOWN ARE ACTUAL SIZE**

## FUEL MANAGEMENT

**GET THE MOST OUT OF YOUR RIDING EXPERIENCE...**

AN AFTERMARKET EXHAUST SYSTEM IS ONLY YOUR FIRST STEP, NOW YOU NEED FUEL MANAGEMENT.

### **NOW YOU NEED FUELPAK.**

Your fuel injected Harley-Davidson® is equipped with an ECU (electronic control unit) that's programmed to deliver fuel to the motor based on an air/fuel ratio for a stock air filter and stock exhaust system. When you install a performance exhaust system, your airflow changes, so you need a fuel management system that adjusts your air/fuel ratio to match the changes. That fuel management system is Fuelpak. Fuelpak adds and takes away fuel, allowing for a more precise range of refinement in your air/fuel ratio. Get the perfect fuel management combination with your Vance & Hines exhaust system, get Fuelpak. For more information visit the tuning center at [fuelpakfi.com](http://fuelpakfi.com)

NOTICE: Fuelpak is intended for racing or off-highway use only, and is not legal for sale or use in California on pollution-controlled vehicles.



**MORE POWER : LESS NOISE**

**13861 ROSECRANS AVENUE / SANTA FE SPRINGS, CA 90670**  
**SALES: (562) 921-7461 / TECHNICAL: (562) 926-5291 / FAX: (562) 802-0110**  
**VANCEANDHINES.COM**